

EOS Econ H3

sauna control unit

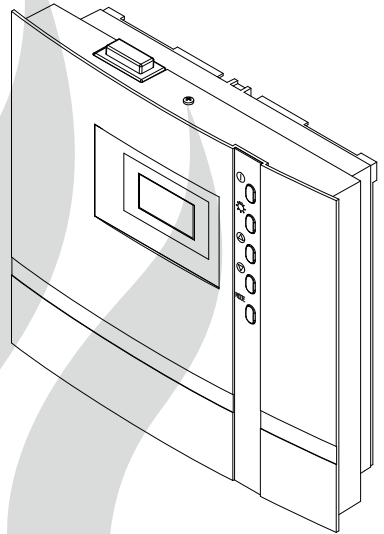

EN

Installation and operating instruction

Made in Germany



Firmware R4.35

Print no. 29344735en / 25.20
Technical changes reserved



English

Table of contents

General information about using the sauna	4
General safety information	5
Scope of Delivery	7
Technical data.....	8
Intended use.....	9
Installation of the control unit.....	10
Wall installation.....	10
Surface-mounted installation.....	10
Recessed installation	11
Connecting the sensor cables	12
Installation of the main sensor.....	12
Installing the optional bench sensor	14
Installing the optional humidity sensor.....	15
Electrical connection	16
Connecting the sauna heater	16
Connecting the vaporizer	16
Connection of a a power extension (LSG).....	16
Connecting the sauna lamp.....	17
Connecting the fan.....	17
Installation diagram	18
Terminal arrangement on the circuit board.	18
Connection diagram for sauna heaters up to 9 kW	19
Connection diagram for sauna heaters above 9 kW	19
Connection diagram for the vaporizer	20
Operation	21
General information.....	21
The user interface	21
Operating buttons	21
Default display Stand-by.....	22
Default display in operation.....	22
Energy-saving display.....	22
Symbol description	23
Operation principle.....	24
Initial commissioning	25
Switching your sauna on / off in dry / humid mode	26

Temperature query.....	26
Individual settings	27
Cabin temperature	27
Humidity mode for time steps	28
Humidity regulation (proportional to time).....	29
Humidity regulation (by connected humidity sensor).....	30
Switching off the sauna unit during humidity operation	31
Auto-stop / heat-up time limitation.....	32
Cabin lighting.....	33
Fan.....	33
Preselection time	34
Activate / deactivate the preselection time	35
Advanced settings	36
Change language.....	36
Change time	36
Switching between °C and °F	37
Switching user profiles (P1-P4)	37
Activate / deactivate the child lock	38
Activate / deactivate the Safety	38
Activate / deactivate the Life - Guard	39
Life-Guard	40
Switching on the sauna unit with Life-Guard	41
Holiday home - Holiday park mode.....	42
Heating time limitation.....	43
Device fuses	44
Error messages	45
The device „Switch-off“ switch	46
Recycling.....	47
Service address	47
General Terms and Conditions of Service.....	48

Preface

Dear customer,
you have purchased a high-quality electronic device with which you will enjoy your sauna & steam bath for many years to come. This device was designed and inspected according to the current European safety standards and manufactured at the factory in accordance with the quality management standard DIN EN ISO 9001:2015.

This detailed installation and operation manual has been prepared for your information. Pay particular attention to the **important notes** and the information on electrical connection.

We wish you a restorative and eventful wellness experience.

General information about sauna bathing

Please note that an optimal interaction between sauna cabin, sauna heater and sauna control unit is mandatory for a pleasant sauna climate in your cabin. With this high-quality sauna control unit you can “operate” your sauna system, and thanks to the many individual programming options, surely you will quickly find the setting which suits you best.

Perception in the sauna is very subjective, therefore, it really requires your own perception or that of your family to find the most suitable settings.

The control units are supplied with the preset typical climate values for a classic Finnish sauna or for models with humidity control, as well as for a sauna with humidity operation.

The following operating instructions describe how to pre-select “your” climate in the cabin. Read these instructions carefully, so that you

quickly and easily find your way through the programming process. Please note the variation in temperatures in the cabin while sauna bathing. The hottest area is directly below the cabin ceiling, whereas there is a steady temperature gradient towards the floor of the cabin. Inversely, the relative humidity is lowest directly below the cabin ceiling and the highest by the cabin floor.

For safety reasons the temperature sensor with the overheat safety shutdown is located on the cabin ceiling above the heater, as this is usually the hottest area in the cabin.

Thus, there will always be temperature variations between the temperature sensor of the control unit and the thermometer in the cabin.



For example, when pre-setting the cabin temperature to 100 °C, the thermometer inside the cabin may show 85 °C - 90 °C. This is in accordance with the typical climate inside the cabin.

Only use sauna-suitable (up to 140 °C temperature-resistant) cabin lights. Always pay attention to hygiene. Always use hand- or bathing towels to avoid getting perspiration on the wood.

For control units with vaporizer connection (optional), we recommend to reheat or dry the cabin after each humid operation, in order to protect your cabin from possible damage due to the humidity mode. In addition, in poorly ventilated rooms, a ventilation fan can be used to remove the used moist air.

To avoid drafts, you should avoid using any ventilation system while sauna bathing. It should only be used if recommended by the cabin manufacturer.

General safety precautions

- This device may be used by children (age 8 and above) and by persons with reduced physical, sensory, or mental disabilities, or inadequate experience and knowledge, if they are supervised or if they have received adequate instructions in how to use the device safely and understand the associated risks.
- Children must be supervised to ensure they do not play with the unit.
- Children and persons who have not received proper instruction must not clean or service the system.
-  **ATTENTION:** It is forbidden to install the control box in a closed switch cabinet or behind a wooden panelling!
- The electrical installation may only be done by a qualified electrical technician.
- You must comply with the regulations of your power supply company and applicable VDE regulations (DIN VDE 0100).
-  **WARNING:** Never attempt repairs or installations yourself, as this could result in serious injury or death. Only a qualified technician may remove the housing cover.
- Please note the dimensions in the installation instructions, especially when installing the temperature sensor. The temperature above the heater is critical for the temperature setting. The temperature can

be held within operating parameters and a minimal deviation at the bench level of the sauna cabin can be achieved only if the device is installed correctly.

- The device may only be used as intended as a control unit for sauna heaters up to 9 kW (up to 36 kW when combined with a power extension unit).
- Completely disconnect the control unit from the electrical circuit, i.e. flip all circuit breakers or the main circuit breaker during each installation or repair.
- Please note the safety and installation information from the sauna heater manufacturer.
- Make sure to observe the specifications and instructions of the sauna cabin manufacturer.
-  **ATTENTION:** For control units with remote control functions*, a protection against switching on if the heater is covered is required. (use the suitable cover protection rail or another safety device).

**Remote control = setting up, controlling or adjusting a unit by a command that can be given out of view of the unit by means of transfer media such as telecommunication, audio technology or bus systems, this also includes weekly timers. (from EN 60335-1)*

 When designing the sauna cabin, ensure that the external exposed glass surfaces may only reach a maximum temperature of 76 °C. If necessary, protective features need to be fitted.

 Inspect the sauna cabin before each use! In particular, ensure that no objects have been stored on the sauna heater or the IR-radiator, if applicable. **Risk of fire!**

 **Attention!**

Dear customer,
according to the valid regulations, the electrical connection of the sauna heater and the control box has to be carried out through the specialist of an authorized electric shop

We would like to draw your attention that in case of a warranty claim, you are kindly requested to present a copy of the invoice of the executive electric shop.

 **Attention!**

Only the original spare parts may be used.
Any modification of the cables included in the delivery can lead to malfunctions and is not permitted.

Any unauthorized technical alteration makes the product warranty void.

Scope of delivery

(changes without prior notice reserved)

The package contents includes:

1. Control unit
2. Temperature sensor, consisting of: sensor board with overheating protection fuse, KTY-sensor, sensor housing, two 3x25 mm fastening screws and 2,0 m sensor cable.
3. Plastic bag with three 4x25 mm fastening screws.
4. 5 rubber cable glands
5. 1 replacement overheating protection fuse
6. Installation and operating manual

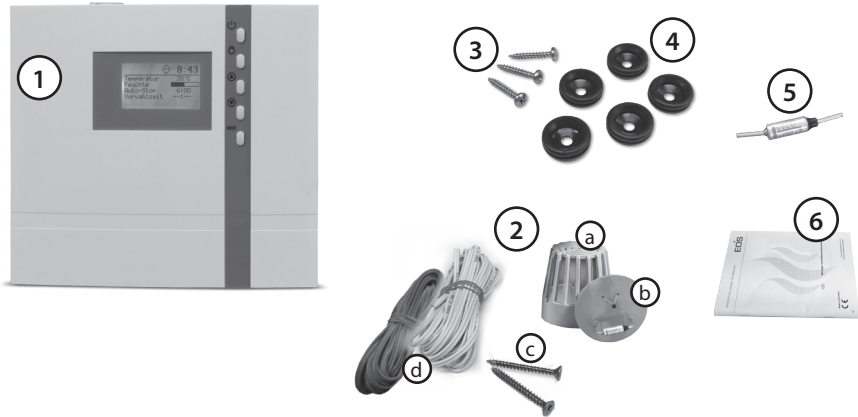

Accessories (optionally available):



Bench sensor (2nd sensor)..... Art.-Nr. 94.4389 (beige)
..... Art.-Nr. 94.5026 (anthracite)



F2 (Humidity sensor)..... Art.-Nr. 90.9479 (beige)
..... Art.-Nr. 94.5027 (anthracite)

Technical data

Voltage (power supply)	400 V 3 N 50 Hz AC
Switch output	max. 9 kW resistive load (AC1 mode) Humidity mode: 6 kW + 3 kW for vaporizer equipment. Can be expanded to 36 kW via the connection of power switching devices
Fuse	3 x 16 A
Heating time limit:	6 h, 12 h / without heat-up time restriction
Display	LCD display 65 x 37 mm, graphic
Dimensions (HxWxD)	220 x 250 x 67 mm
Protection type	IPx4 acc. to EN 60529 splashwater protection
Temperature control range	sauna mode: 30 to 115 °C humidity mode: 30 to 70 °C
Humidity control	without humidity sensor: time-proportional (10 levels) with F2 humidity sensor: per relative air humidity in %
Water level monitoring	Lack of water in the vaporizer will cause the heating system to shut down after 2 minutes (only with compatible sauna heaters).
Sensor system (temperature)	KTY-sensor with safety temperature limiter 139 °C
Control characteristic	Two-point control with fixed hysteresis of 3K. For control via the stove sensor offset of 7K to compensate the higher tem- peratures directly below the cabin ceiling
Fan	max. 100 W
Light	max. 100 W
After-heating	30 min. at 90°C after turning off the humidity program
Ambient temperatures	-10 °C to +40 °C
Storage temperature	-20 °C to +70 °C
Temperature display stove sensor	Current value on the stove sensor minus 7K to compensate the higher temperatures directly below the cabin ceiling
Temperature display bench sensor	Current value on the bench sensor

Intended use

This sauna control unit is exclusively intended for the control of the sauna heater in a sauna cabin. Any other use over and above the intended purpose is not considered as appropriate use! Compliance of the standard operation, maintenance and repair conditions is also an element of appropriate use.

The manufacturer cannot be held liable for deviating, unauthorized alterations and any resulting damages: the initiator of these changes bears the full risk.

Important note!

The device must be protected against the adverse weather conditions. It must not be used in extremely humid or wet environments with possible formation of condensate or corrosive substances in the ambient air. Also avoid inadmissible ambient temperatures and direct sunlight. If there is an increased risk of mechanical damage, the control unit must be protected accordingly.

Installation of the control unit

Wall installation

The control unit may only be mounted outside the cabin. For sauna rooms it is advisable to select the outside wall of the cabin to which the sauna heater is fixed from the inside as mounting position. If ductwork is already provided for electrical installations then the position of the control unit is predetermined by that. Please follow the instructions for installation:

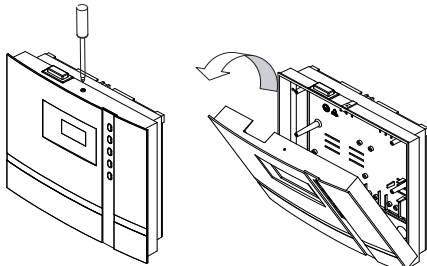

Fig. 1

Remove the control device cover. In order to do this loosen the screw at the top of the housing and pull the housing top upward while swiveling (Fig. 1).

Surface-mounted installation

1. The 3 mm diameter boreholes for the supplied wood screws 4 x 20 mm to be drilled according to the dimensions shown in Fig. 3 + 3.1.
2. Insert one of the wood screws into the top center hole. The control unit is hooked onto this screw. Therefore, leave the screw out by approx. 3 mm (Fig. 3.2).
3. Hook the control unit onto the 3 mm protruding screw in the upper mounting hole. Insert the supplied rubber grommets into the openings at the rear wall of the housing and insert the connecting cable through these openings.

Fasten the housing bottom at the two bottom openings (Fig. 4) firmly to the cabin wall.

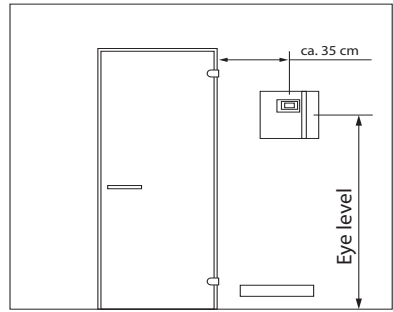

Fig. 3

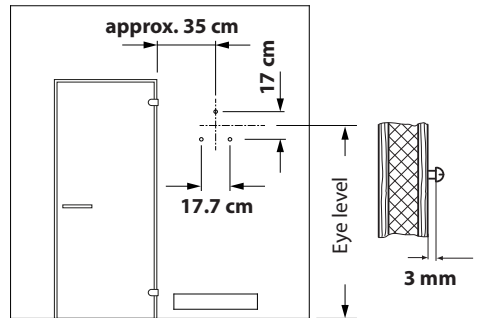
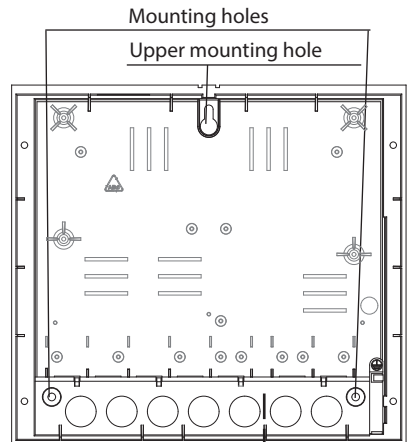

Fig. 3.1

Fig. 3.2



Feed-through for example:
 Mains cable
 Heater cable
 Evaporator cable
 Lamp
 Fan

Feed-through for:
 sensor lines

Fig. 4

Recessed installation

1. Cut out a wall section that is at least 3.5 cm deep according to the dimension in Fig. 5.

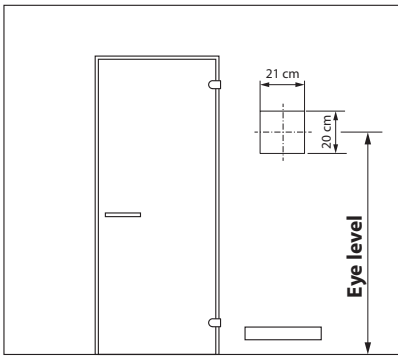
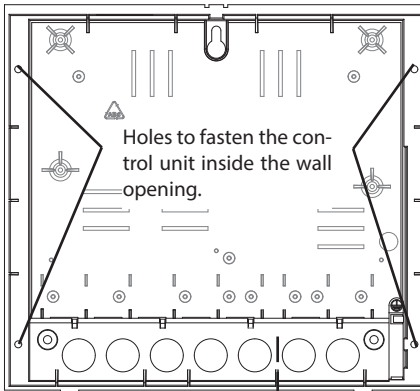

Fig. 5

Insert the supplied rubber grommets into the openings at the rear wall of the housing and insert the connecting cables through these openings.

Place the control unit into the wall opening and fasten it with 4 wood screws.



Feed-through for:

- Mains cable
- Heater cable
- Vaporizer cable
- Lamp cable
- Fan cable

Feed-through for:
sensor lines

Fig. 6

Connecting the sensor cables

You should not install sensor and power supply lines together, or lead them through the same feedthrough. This can lead to interferences in the electronics, such as "fluttering" in the relays. If it is necessary to lay the cables down together, or if the line is longer than 3m, use a shielded sensor cable (4 x 0.5 mm²).

Connect the shielding to ground in the control unit.

Please observe that the following dimensions relate to the values stipulated during the unit inspection acc. EN 60335-2-53. The heater sensor must always be installed at the point where the highest temperatures are to be expected. Illust. 7-9 give you an overview of the mounting point of the sensor.

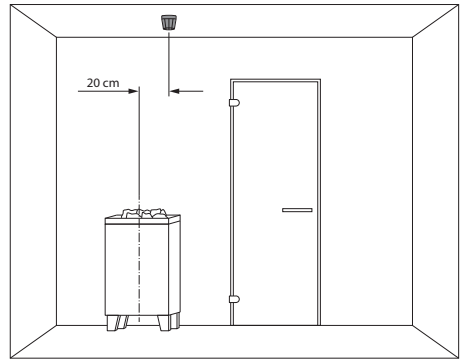

Fig. 9

2. Drill a hole to lead the cable through, preferably through the middle of one of the wooden boards.
3. Lead the sensor cable through the drilled hole and attach it to the sensor line according to Illust. 10.
4. The cables for the limiter (white) and the temperature sensor (red) are connected to the sensor circuit board acc. Fig. 10. Engage the sensor board into the casing.



Installation of the main sensor

1. Mount the oven sensor in cabins up to 2 x 2m according to fig. 7 and 9, in larger cabins according to fig. 8 and 9.

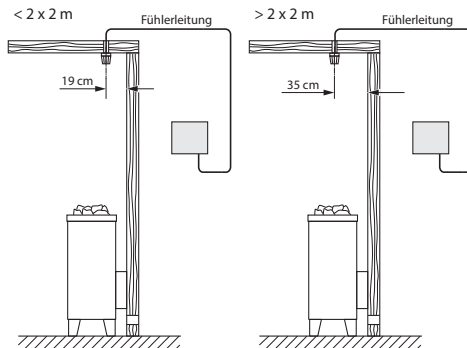
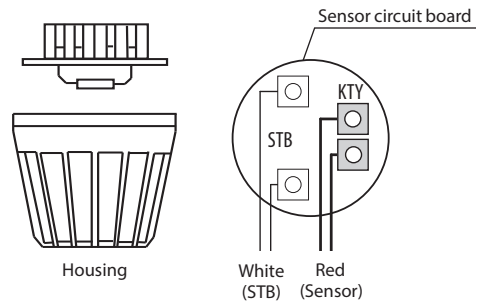

Fig. 7

Fig. 8



5. Lead the sensor cables through the right cable intake into the control unit. Install the sensor cables inside the control unit as shown in Fig. 11.

Connect the sensor cables as shown in Fig. 12. In order to do this, pull the plug **X2** from the circuit board and plug it back in after the connection.

Fig. 10

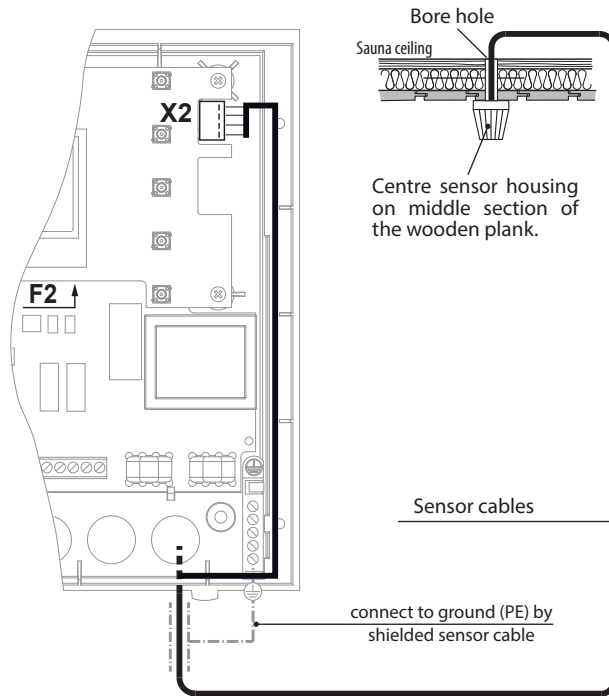

Fig. 11

Notice

Equipment damage due to incorrect connection.

Mixing up the connection on X2 connection can cause the fuse F2 to blow and damage the control (for replacement please refer to the chapter „Device fuses“)

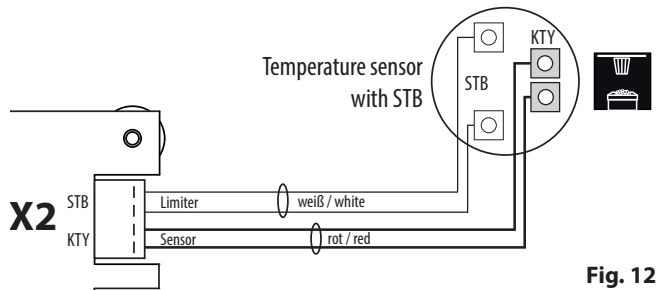
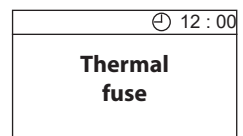

Fig. 12

- After completed installation and before commissioning of the control unit the line for overheating protection fuse must be checked for proper functionality. For this disconnect one of the white cable wires at X2 connector. The respective error message appears in the display. Re-connect the wire.





Installation of the optional second temperature sensor (bench sensor)

Installation place: The bench sensor shall be mounted to the ceiling over the rear wall bench opposite to the heater as described in the installation of the bench sensor.

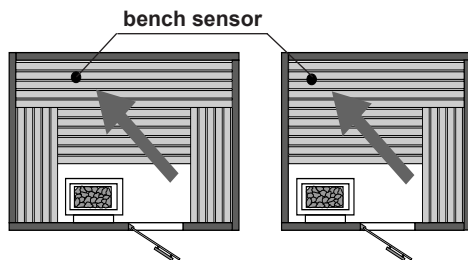

The bench sensor is connected with a 2-core silicone cable from the sensor pcb to the terminals on the right-hand side of the main board of the sauna controller (X2), as shown below.

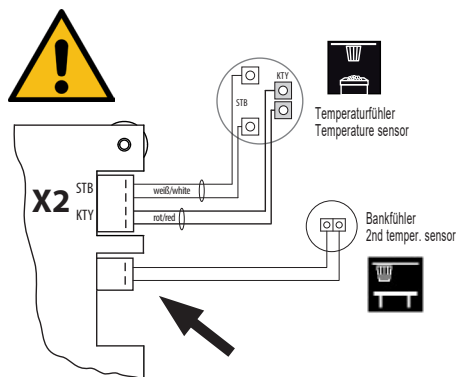

If the sensor is connected correctly, the control unit shall automatically recognise it once the mains voltage has been switched on again.

By faults of the second sensor the following error messages will be displayed:

„Sensor break“ - interruption of the sensor circuit (e.g. faulty contact).

or

„Sensor short“ - short circuit of the sensor

In this case, the sensor must be checked by a specialist and replaced if necessary. At room temperature 20 °C, the sensor has approx. 2 kΩ resistance.

In order to keep on operating your sauna cabin despite the second sensor fault switch the unit from power supply, disconnect the cable connection to the second sensor and restore the power supply.

Once the problem has been solved, the control unit shall recognise the sensor after it has been re-connected and the mains voltage has been switched on again



Humidity sensor installation (optional equipment)

1. The humidity sensor shall be mounted in the middle of the side wall which is opposite to the stove at a height of approx. 150 cm. See example below.

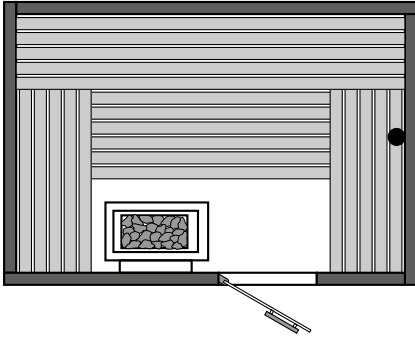

2. Please observe the wiring scheme of sensor connection as shown below.
3. Please ensure that the connection is made correctly - incorrect connections can cause a fault in the sensor.

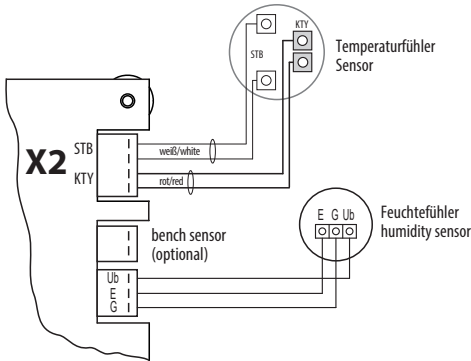

Sensor circuit board

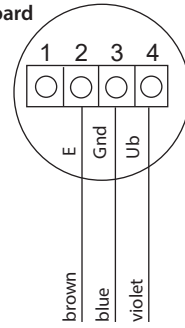

Fig. 13

Connect the cable wires to the sensor board as shown on the fig. 13.

Climate control

By humidity control via the humidity sensor the climate is controlled basing on the pre-set temperature-to-humidity dependence curve which is shown on the below chart. All climate values left to or below the curve (green zone) can be selected and used (Fig. 14).

⚠ Attention! Climate values to the right of the curve cannot be programmed as potentially dangerous. Risk of scalding!

Programmable climate conditions as per EN 60335-2-53:2012 norm.

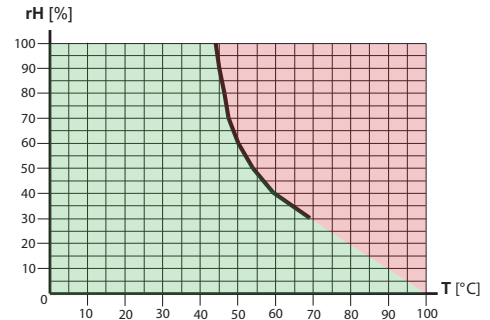

Allowed settings

Prohibited settings

Fig. 14

Electrical connection

The electrical connection may only be done by a certified electrician in compliance with the guidelines of the local utility company and the VDE.

In general, there may be only one fixed connection to the network; therefore equipment should be provided that makes it possible to disconnect the system with all poles from the network with a contact opening width of minimum 3 mm.

All electrical installations and all connection lines that are installed inside the cabin must be suitable for an ambient temperature of at least 170 °C.

The power supply line is run to the control unit and connected to the power input terminals.



Attention! Danger to life!

Swapping the phase wire with the neutral wire by control unit connection can damage the control unit and override the safety-relevant components.



Connecting the sauna heater

Install the sauna heater with the vaporizer in front of the air inlet according to the manufacturer's installation instructions.

Run the silicone line through the ductwork to the power unit and connect it to the appropriate terminals as directed in the wiring diagram.

Note: If there are no hollow tubes, drill a hole next to the vent inlet opening and feed the stove supply line(s) to the outside through this hole to the respective terminals on the control unit. The silicone line needs to be hidden to protect it from external influences. Therefore use a suitable cable duct or a PVC tube to guide the line to the control unit.



Connecting the vaporizer

Use a silicone coated cable 4 x 1.5 mm² to connect the vaporizer. Observe the connection scheme in the installation manual of the vaporizer (sauna heater). Max. vaporizer power 3000 W.

Note that for test purposes the vaporizer will shortly switched on for 1 min when the control unit is switched on in humid mode. After that the vaporizer will be switched off and will be only switched on again when the cabin reaches a temperature that is 10K below the pre-set temperature.

This prevents steam production while the sauna cabin is still too cold.



Warning: When connecting the vaporizer make sure it is correctly attached to the water bath (WB) and the water shortage switch-off (WM) terminals. If you swap these connections, you disable the water shortage alarm function and bypass the overheating thermostat. This can cause the overheating of the vaporizer and damage it.

Risk of fire!

The control unit can detect water shortage if there is a zero-potential feed at the WM terminal input.



Connecting a power extension (LSG)

An optional power expansion relay box / contactor box (LSG) can be connected by sauna heaters above 9 kW power.

For more details, please refer to the assembly instructions of the power switching device (LSG).



Connecting the sauna lamp

Connect the sauna lamp as shown on the connection scheme.

The sauna light must comply to the water splash proof protection class (IPx4) and must be resistant to the ambient temperature. The sauna light can be mounted anywhere but near the uprising warm airflow of the heater.

Please observe the maximum allowed power of the light output (100 W).



Connecting the fan

Please observe the maximum allowed power of the fan output (100 W).

The fan should have the protection class adequate to the installation situation and must be resistant to the ambient temperature.

The fan can be mounted anywhere but near the uprising warm airflow of the heater. Make sure to observe the installation manual of the fan manufacturer.

Installation diagram

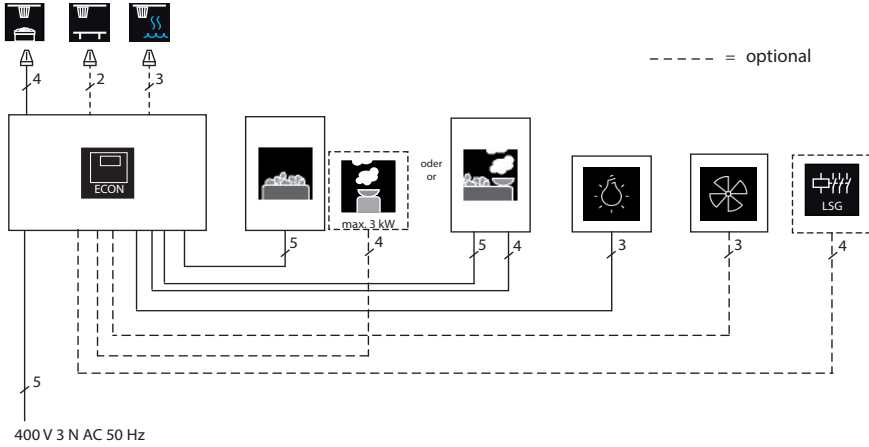

The control lamp for public systems without heat-up time restriction must be installed in the supervisor's room.

Terminal arrangement on the circuit board

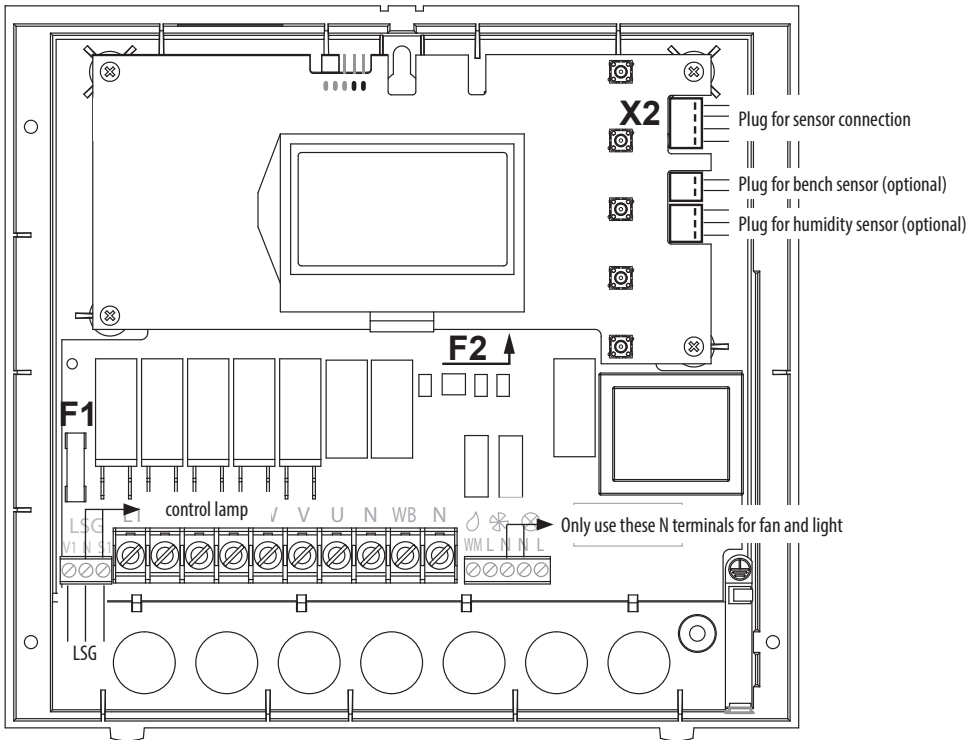

Connection diagram for sauna heaters up to 9 kW

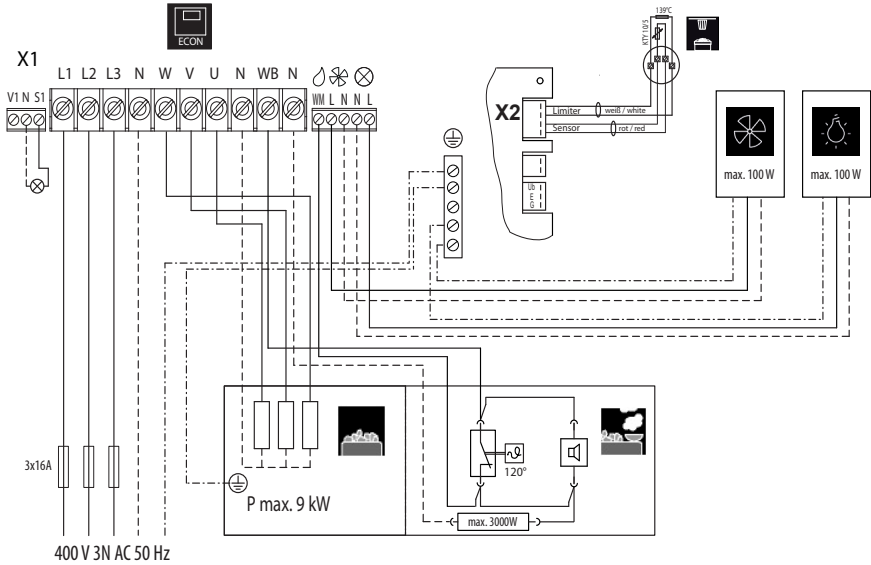

⚠ Caution: Always connect the neutral conductor (N) of the sauna stove. In humidity mode, one phase of the sauna stove is deactivated, i.e. the heating load is not symmetrical. The result is that the neutral conductor is then no longer currentless.

Connection diagram for sauna heaters above 9 kW

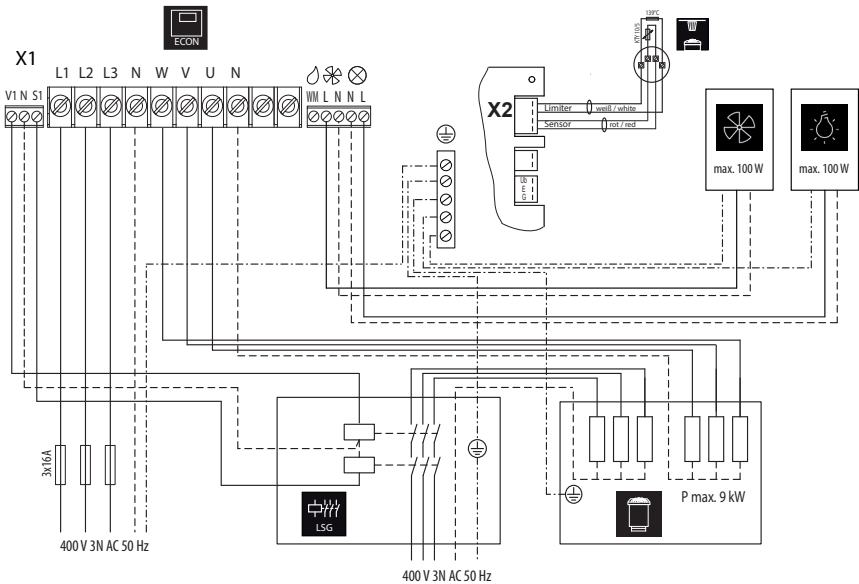

Connection diagram for the vaporizer

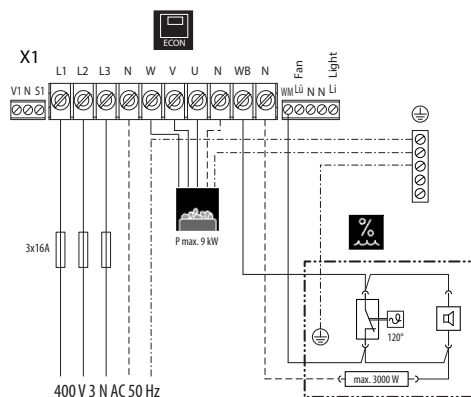



CAUTION

By humid sauna operation (active vaporizer) the output "U" is diverted to the terminal "Wb" of the vaporizer.

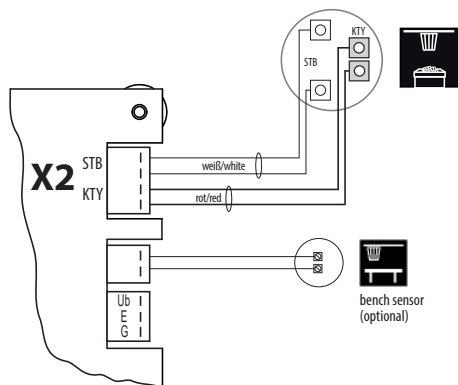
In this case the sauna heater heats only with two thirds of the power.



 By detected water shortage the control unit will switch off the heating after 2 minutes. To start the sauna again, first switch off the heating with the on/off  button and refill the vaporizer with water. After that you can start the sauna again (humid mode). Please allow a few minutes for the vaporizer to cool down by overheating.

Operation

Once the system has been installed with all components and all covers have been fixed, you can put the control unit into operation.

Please read the following information to get yourself familiar with the functions and capabilities of your sauna control unit.

General information

The user interface

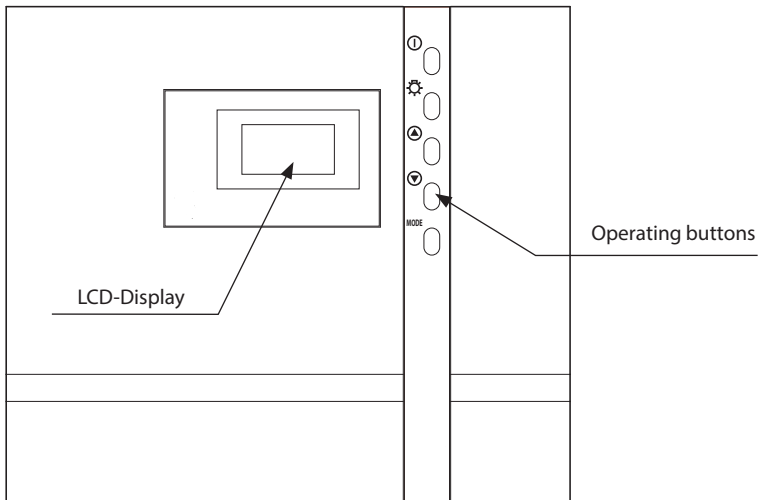

Operating buttons

 = on / off (stand-by)

 = cabin lighting

 = next function / increase value (up)

 = next function / decrease value (down)

MODE = programming mode / save setting

Default display Stand-by

is shown if the system is in Stand-by mode.

The system also returns to this screen from other menu items, if there is no activity for >15 seconds.

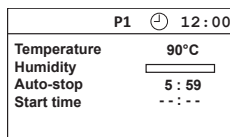

Default display in operation

is displayed if the system is operational. The system also returns to this screen from other menu items, if there is no activity for >15 seconds.

Illustration of the heating performance:

During the heating phase the bars behind the temperature display fill continuously.

Once the target temperature has been reached, these bars are displayed as filled.

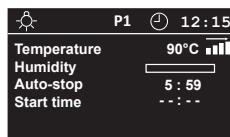

Energy-saving display

If the unit is not used, it will switch into energy-saving mode.

A moving time is shown after 5 minutes, similar to a PC screensaver. The back light for the display is switched off after an additional 15 minutes.

You can return to the basic standby screen by pressing any button.

To start heating press the On/Off button for >3 seconds.

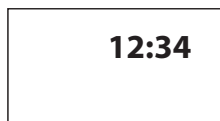

Symbol description













R P1

12:00

The following is shown in the top area of the display:

	Light-Symbol	<ul style="list-style-type: none"> • Light switches on automatically when heating is switched on • Light stays on 30 min. after the heating stops • Manual light switching is possible at any time
	Clock-Symbol	<ul style="list-style-type: none"> • Time indication
12 : 00	Time	<ul style="list-style-type: none"> • Displays the time of day
	After-heating phase	<ul style="list-style-type: none"> • After-heating - 30 minutes at 90°C after humid operation model
	Operation lock	  <ul style="list-style-type: none"> • Locks all buttons but still allows to switch off heating if the sauna is currently running. • Light still can be switched on and off
	Timer active	<p>Functions only if the availability of a fire protection system has been confirmed (setup - "safety" option has been checked as available).</p> <ul style="list-style-type: none"> • If shown continuously on - single event timer activated • If flashing - recurring switching timer activated
P1	User profiles P1-P4	 <ul style="list-style-type: none"> • Four user profiles P1-P4 with pre-set popular climate conditions • Every profile can be changed <p>3 sec.</p>
	Holiday home mode Holiday park mode	<ul style="list-style-type: none"> • Holiday home mode =symbol static, restricted access mode • Holiday park mode =symbol flashing, restricted access, only on/off possible

Operation principle

For settings press shortly the **MODE** button.

The first parameter (temperature) will be selected and shown inverted.

Use the ▲ or ▼ buttons to navigate to the required parameter which you would like to adjust.

☀ P1 ⌚ 12:00	
Temperature	90°C
Humidity	▬
Auto-Stop	5:59
Start time	--:--

Parameter values that flash on the display can be changed and are shown in this manual as displayed.



Press the **MODE** button again shortly to start the adjustment for the selected parameter.

The background of the value of the selected parameter will be flashing.

Now you can adjust this value using the ▲ or ▼ buttons.

All settings made in the standby mode should be confirmed by pressing **MODE** for >3 secs and are then saved in the current profile.

The parameter stops flashing and the new value becomes valid until it is changed again.

☀ P1 ⌚ 12:00	
Temperature	90°C
Humidity	▬
Auto-Stop	5:59
Start time	--:--

Modifiable parameter

☀ P1 ⌚ 12:00	
Temperature	90°C
Humidity	▬
Auto-Stop	5:59
Start time	--:--

Modifiable value

If no button is pressed for >15 secs, the device returns to the standard screen. Any changes made will not be saved.

☀ P1 ⌚ 12:00	
Temperature	90°C
Humidity	▬
Auto-stop	5:59
Start time	--:--

Initial commissioning

Set language (DE, GB, IT, NL, PL, RU, FR, SE, ES, CZ, FI, SLO)

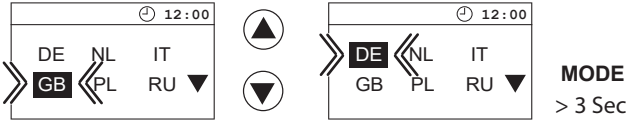

Set time of day (0:00 bis 23:59)

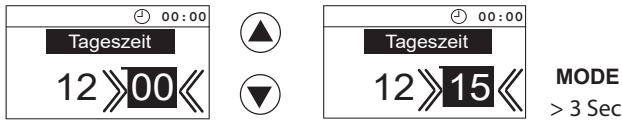
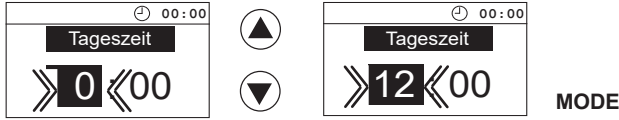

Set Life-Guard function



Enable or disable Life-Guard

Select and confirm one of the following:

- disable, or - enable.

Safety



Is a safety system as per EN-Norm 60335 for remote & automatic operation available?

Select and confirm one of the following:

- no, not available, or - yes, available.

Attention, make sure to observe the General Safety Precautions section, page 5!

Set fan ("0"/"1": fan off / on)

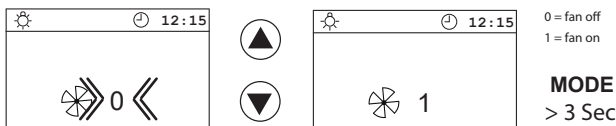

Stand-by

P1		⌚ 12:00
Temperature	90°C	
Humidity	<div style="width: 50%; border: 1px solid black;"></div>	
Auto-stop	5:59	
Start time	--:--	

Switching your sauna on in a dry (Finnish) mode

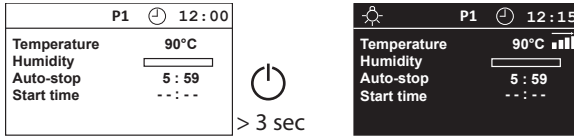

Switching your sauna off (dry sauna mode)



Temperature query (only when heating is on, not in stand-by or during sauna-dry mode.)

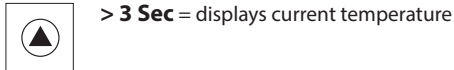

Finnish



Finnish

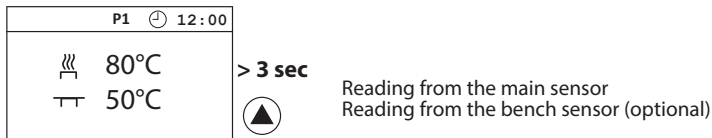

Bi-O (humid mode)

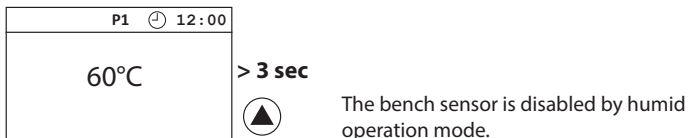

Individual Settings

The following are options for adapting the control systems to your individual needs. The parameters can be adjusted both in standby or in operation mode and the changes are then saved in the device. Changes made in operation mode will apply immediately once saved.

Cabin temperature Setting range: Dry sauna operation 30 - 115°C
 Humidity mode 30 - 70°C

In Stand-by

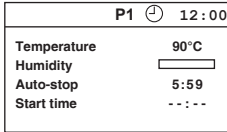

MODE

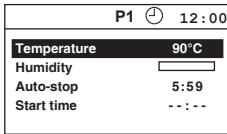

MODE

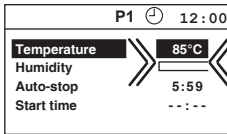
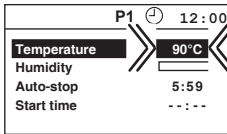

MODE > 3 sec.

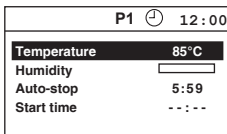

15 Sek. / > 3 sec.

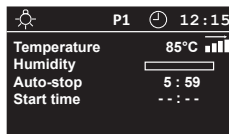
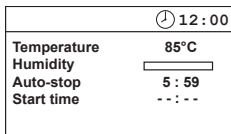

In operation

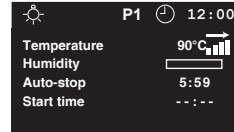

MODE

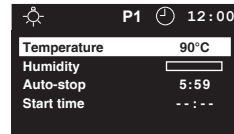

MODE

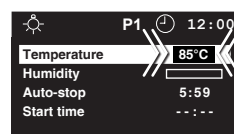
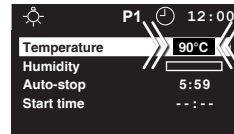

MODE > 3 sec.

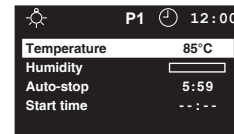

15 sec.

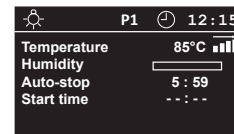



Humidity mode for time steps (without humidity sensor)

A prerequisite for humidity mode is the connection of a suitable vaporizer device up to max. 3 kW at 230 V AC. The control system "clocks" the vaporizer depending in the set humidity target value.

Note: When the vaporizer is activated, the stove only heats with two phases, i.e. one of the switching phases is switched to the vaporizer. In symmetrically wired stoves (same heat output per phase) only 1/3 of the heat output of the sauna stove is switched off. This firstly protects the user against excessive temperatures and also limits the switch output to 3 kW per phase.

The humidity to be achieved is strongly dependent on the geometry of the sauna cabin, the sauna heater used and the vaporizer power. Therefore, you will have to find your own personal climatic zone. Always select the temperature first (from 30 to 70°C) and then the humidity.

When the stove and vaporizer are set to the optimum to the sauna cabin, the humidity values in the table can be reached during a 100% activation period.

Temperature	Rel. air humidity
60 °C	50%
50 °C	60%
40 °C	70%
30 °C	80%

The achievable values lie above the values that are actually required. Therefore reduce the values after the heat-up phase. Please note that the cabin temperature is at its highest directly below the cabin ceiling, although the relative air humidity is low here. The relative air humidity increases in line with the sinking temperatures from the cabin ceiling to the cabin floor.

The following diagrams show

you the temperature values via the relative air humidity for the most common sauna shapes and comfort zones.

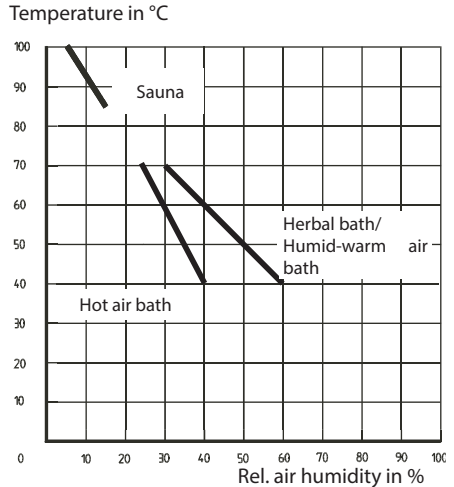

The humidity intensity shown in the display corresponds to the time-proportional vaporizer setting. Therefore the relative air humidity is not pre-selected or shown in the display, instead the activation frequency of the vaporizer is shown as a percentage. This is explained in the diagram.

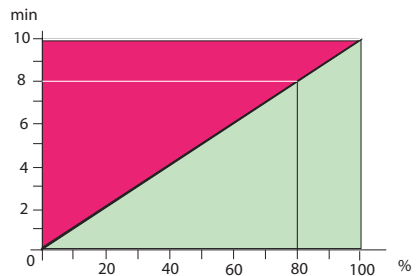

The vaporizer is always controlled if a value is shown in the "humidity" field. Please also note that the vaporizer is only activated after a dry Finnish mode when the temperature in the cabin has dropped to the allowed value.

Humidity regulation (proportional to time) (Range 1-10)

If a value is entered by humidity the sauna unit automatically goes into humidity operation when switched on. The vaporizer will switch on for a short time to indicate it is functional and will switch off. It will switch on again when the temperature is close to the set-point.

In Stand-by

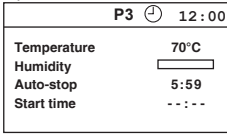

MODE

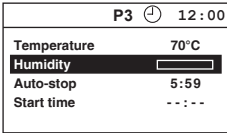
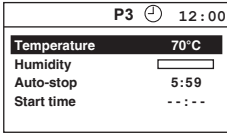

MODE

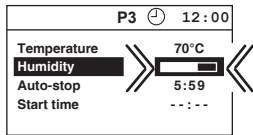
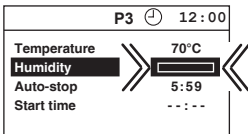

MODE > 3 sek.

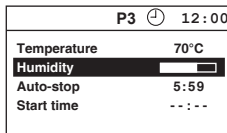

15 sek. / > 3 Sek

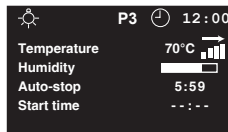
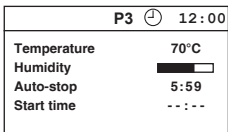

In Operation

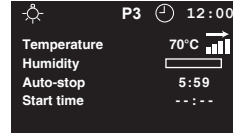

MODE

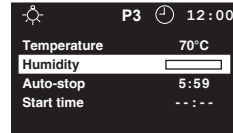
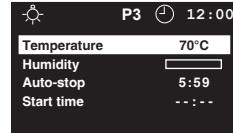

MODE

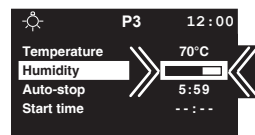
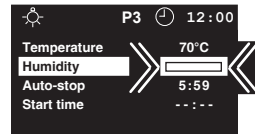

MODE > 3 sek.

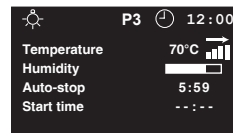

15 sek.

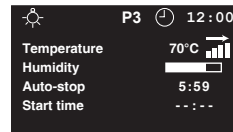



Humidity regulation (by connected humidity sensor)

Humidity intensity: If a value is entered here the sauna unit automatically goes into humidity operation when switched on.

In Stand-by

P4	🕒	12:00
Temperature	60°C	
Humidity	30 %	
Auto-stop	5:59	
Start-time	--:--	

MODE

P4	🕒	12:00
Temperature	60°C	
Humidity	30 %	
Auto-stop	5:59	
Start-time	--:--	



P4	🕒	12:00
Temperature	60°C	
Humidity	30 %	
Auto-stop	5:59	
Start-time	--:--	

MODE

P4	🕒	12:00
Temperature	60°C	
Humidity	30 %	
Auto-stop	5:59	
Start-time	--:--	



P4	🕒	12:00
Temperature	60°C	
Humidity	70 %	
Auto-stop	5:59	
Start-time	--:--	

MODE > 3 sec.

P4	🕒	12:00
Temperature	60°C	
Humidity	70 %	
Auto-stop	5:59	
Start-time	--:--	

15 sek. / ⏻ > 3 sec.

P4	🕒	12:00
Temperature	60°C	
Humidity	70 %	
Auto-stop	5:59	
Start-time	--:--	

☀️	P4	🕒	12:00
Temperature	60°C		
Humidity	70 %		
Auto-stop	5:59		
Start-time	--:--		

In Operation

☀️	P4	🕒	12:00
Temperature	60°C		
Humidity	30 %		
Auto-stop	5:59		
Start-time	--:--		

MODE

☀️	P4	🕒	12:00
Temperature	60°C		
Humidity	30 %		
Auto-stop	5:59		
Start-time	--:--		



☀️	P4	🕒	12:00
Temperature	60°C		
Humidity	30 %		
Auto-stop	5:59		
Start-time	--:--		

MODE

☀️	P4	🕒	12:00
Temperature	60°C		
Humidity	30 %		
Auto-stop	5:59		
Start-time	--:--		



☀️	P4	🕒	12:00
Temperature	60°C		
Humidity	70 %		
Auto-stop	5:59		
Start-time	--:--		

MODE > 3 sec.

☀️	P4	🕒	12:00
Temperature	60°C		
Humidity	70 %		
Auto-stop	5:59		
Start-time	--:--		

15 sek.

☀️	P4	🕒	12:00
Temperature	60°C		
Humidity	70 %		
Auto-stop	5:59		
Start-time	--:--		

By connected humidity sensor the humidity value shown in the display corresponds to the relative air humidity around the humidity sensor. The humidity value is set or shown in the display in % rel. air humidity. The allowed settings are shown on the below chart (any value to the left of the curve)



The vaporizer will be only switched if a value has been set and is shown in the "humidity" parameter.

Please note that after a dry sauna operation the vaporizer can be only activated if the air temperature in the cabin has dropped below the allowed (safe) value which corresponds to the selected humidity. The air temperature should be below 70°C in any case.

If you have operated the sauna at e.g. 90 °C and then switch to humidity mode, the vaporizer will only be activated if the air temperature has cooled to the maximum allowed value (max 70°C or lower as per selected humidity).

Switching off the sauna unit during humidity operation

To dry out the sauna cabin after the humidity mode, a „sauna-dry mode“ is activated after the main heating has been switched off. The cabin will be heated at 90°C for approx. 30 minutes. This phase will be indicated in the upper part of the display with the flashing  symbol. Also the extractor fan, if installed, will be activated at full speed for the duration of the sauna-dry operation.

The sauna unit automatically turns off once this time has expired.

If you want to stop the sauna-dry mode, press the  button again.

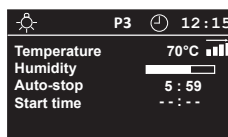

Auto-Stop. / 

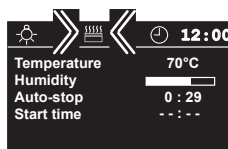

Auto-Stop. / 

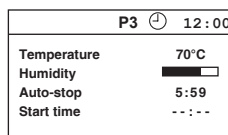

Auto-stop / heat-up time limitation

Auto-Stop defines the heating time limitation. The sauna unit automatically turns off once this time has expired.

Depending on the configuration of the control unit, a time between 0:30 to 6:00, 0:30 to 12:00 hours or unlimited can be set. This setting is valid for all user profiles P1-P4.

Attention! The allowed time for private operations is 6 hours.

In Stand-by

P1 12:00	
Temperature	90°C
Humidity	<input type="text"/>
Auto-stop	5:59
Start time	--:--

MODE

P1 12:00	
Temperature	90°C
Humidity	<input type="text"/>
Auto-stop	5:59
Start time	--:--



P1 12:00	
Temperature	90°C
Humidity	<input type="text"/>
Auto-stop	5:59
Start time	--:--

MODE

P1 12:00	
Temperature	90°C
Humidity	<input type="text"/>
Auto-stop	5:59
Start time	--:--



P1 12:00	
Temperature	90°C
Humidity	<input type="text"/>
Auto-stop	8:59
Start time	--:--

MODE

P1 12:00	
Temperature	90°C
Humidity	<input type="text"/>
Auto-stop	3:59
Start time	--:--



In operation

P1 12:00	
Temperature	90°C
Humidity	<input type="text"/>
Auto-stop	5:59
Start time	--:--

MODE

P1 12:00	
Temperature	90°C
Humidity	<input type="text"/>
Auto-stop	5:59
Start time	--:--



P1 12:00	
Temperature	90°C
Humidity	<input type="text"/>
Auto-stop	5:59
Start time	--:--

MODE

P1 12:00	
Temperature	90°C
Humidity	<input type="text"/>
Auto-stop	5:59
Start time	--:--



P1 12:00	
Temperature	90°C
Humidity	<input type="text"/>
Auto-stop	3:59
Start time	--:--

MODE

P1 12:00	
Temperature	90°C
Humidity	<input type="text"/>
Auto-stop	3:59
Start time	--:--



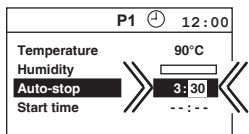

MODE > 3 sec.

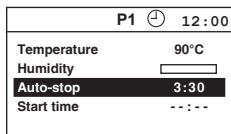

15 sec. / > 3 sec.

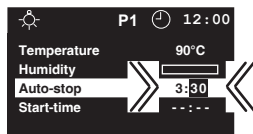

MODE > 3 sec.

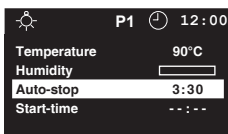

15 sec. /

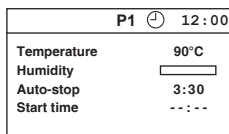
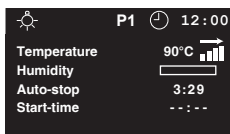
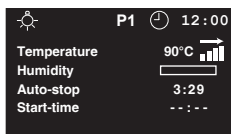
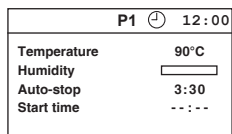

Cabin lighting

Every time that the sauna system is activated, the cabin lighting is automatically switched on. The symbol is shown at the top left of the display. If the sauna system is switched off, the cabin lighting is also switched off after a delay of 30 minutes.

Regardless of the operational state of the sauna system, the cabin lighting can be switched on or off at any time via the button.

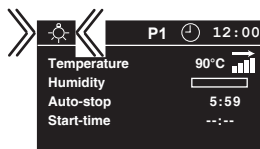

Fan

The fan can only be switched on or off. This setting is entered when the system is commissioned for the first time, however it can be changed at a later time (see below).

MODE &

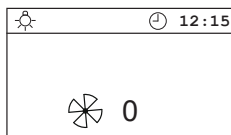
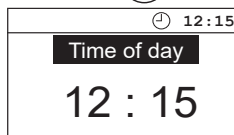

MODE

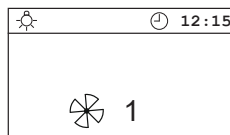
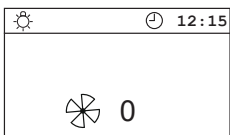

MODE
> 3 sec.

Preselection time

The switching time preselection function is a timer which allows you to automatically switch your sauna up to 24 h in advance or enable recurring automatic switching. Note: by disabled Safety the time pre-selection will be shown but cannot be programmed.

Single-even switching: Set start time up to 24 h in advance and press On/Off button shortly. A bell symbol will appear on screen.

Recurring switching: Set start time and press On/Off button >5 sec until the bell symbol on screen flash-



Always make sure that there are no objects on the sauna unit before the heating process begins. Risk of fire!

Please note that the cabin requires some around 1 h to heat up. If, for example, you wish to start with your sauna bath at 18:00, we recommend to select 17:00 as your preselection time.

If you wish to start sauna manually set the "Start time" to "--:--". Note if „00:00“ is entered, the sauna will start at 00:00! If the preselection time is activated, the sauna can only be switched off manually.

In Stand-by

	P1	🕒	12:00
Temperature	90°C		
Humidity	▬		
Auto-stop	5:59		
Start time	--:--		

MODE

	P1	🕒	12:00
Temperature	90°C		
Humidity	▬		
Auto-stop	5:59		
Start time	--:--		



	P1	🕒	12:00
Temperature	90°C		
Humidity	▬		
Auto-stop	5:59		
Start time	--:--		

MODE

	P1	🕒	12:15
Temperature	90°C		
Humidity	▬		
Auto-stop	5:59		
Start time	--:--		



	P1	🕒	12:15
Temperature	90°C		
Humidity	▬		
Auto-stop	5:59		
Start time	17:--		

MODE

In operation

	P1	🕒	12:00
Temperature	90°C		
Humidity	▬		
Auto-stop	5:59		
Start time	--:--		

MODE

	P1	🕒	12:00
Temperature	90°C		
Humidity	▬		
Auto-stop	5:59		
Start time	--:--		



	P1	🕒	12:00
Temperature	90°C		
Humidity	▬		
Auto-stop	5:59		
Start time	--:--		

MODE

	P1	🕒	12:15
Temperature	90°C		
Humidity	▬		
Auto-stop	5:59		
Start time	--:--		



	P1	🕒	12:15
Temperature	90°C		
Humidity	▬		
Auto-stop	5:59		
Start time	17:--		

MODE

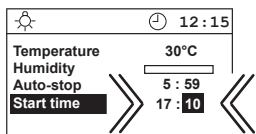
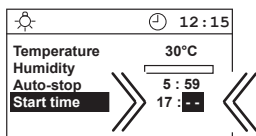

MODE > 3 sec.

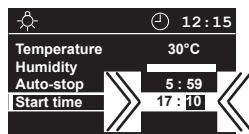
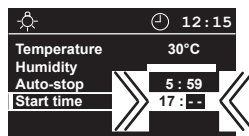

MODE > 3 sec.

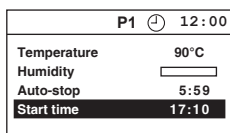

15 sec. /

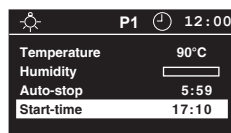

15 sec. /

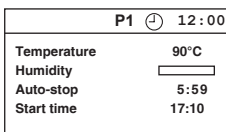
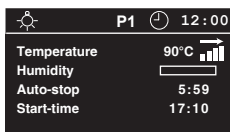
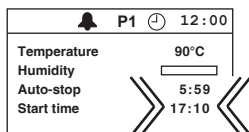
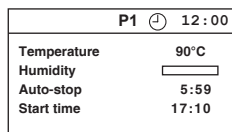

At the selected time

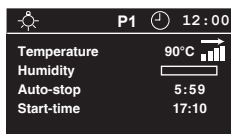

Deactivate the time preselection

Activate the time preselection

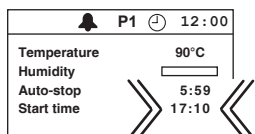

Zur vorgewählten Zeit

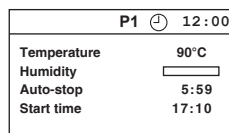
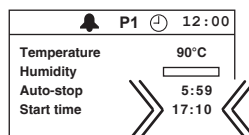
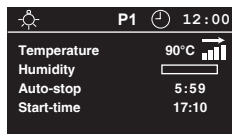

If the sauna unit is to be used without preselection time, "--:--" must be entered in the display under preselection time.

Advanced settings

Change language

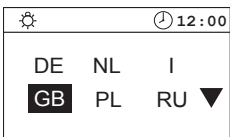
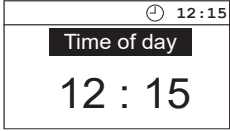
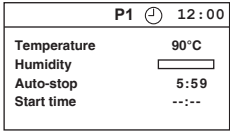

MODE

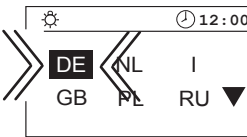

MODE > 3 sec



Change time

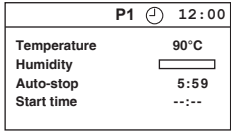

MODE



MODE

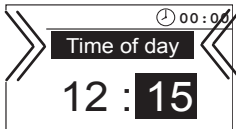
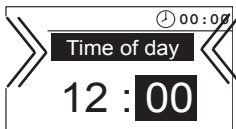

MODE > 3 sec

Switching between °C and °F

You can select between °C or °F display if you switch the controller off and then switch it on again while holding the button  pressed.

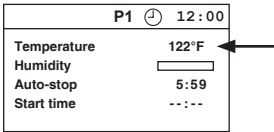
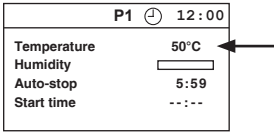

Switching user profiles (P1-P4)

You can select between user profiles by pressing the  button for > 3 sec.

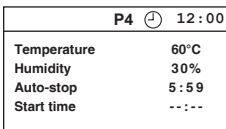
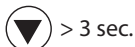
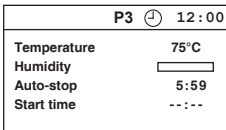
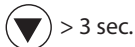
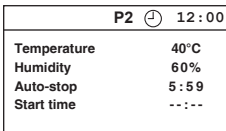
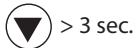
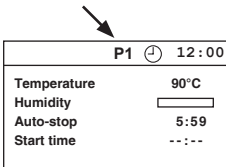

The 4 changeable cabin configurations (P1-P4) allow different settings of temperature and humidity in dry or humid mode.

The heating time limitation and the start-time is the same for all.

Factory setting:

P1 target temperature dry (Finnish): 90°C

P2 target temperature humid (Bi-O): 40 °C with 6 / time steps or 60% relative humidity (with connected humidity sensor)

P3 target temperature dry (Finnish): 75°C

P4 target temperature Bi-O: 60 °C with 3 / time steps or 30% relative humidity (with connected humidity sensor)

The programs P1-P4 can be individually adapted as described in settings: temperature and humidity.

Activate / deactivate the child lock

If the child lock is activated (the key symbol is visible in the top section of the display) only the cabin lighting can be switched. All other buttons are without function. The child lock can be activated / deactivated in Stand-by as well as in operation. The unit can still be switched off when in operation.

Activate

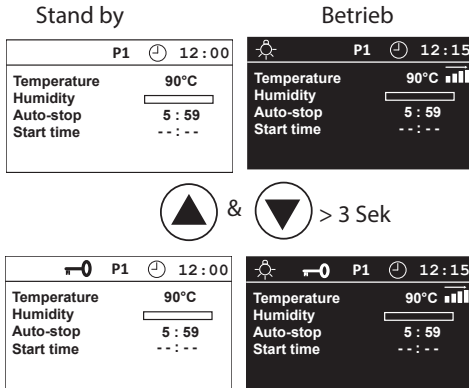

Deactivate

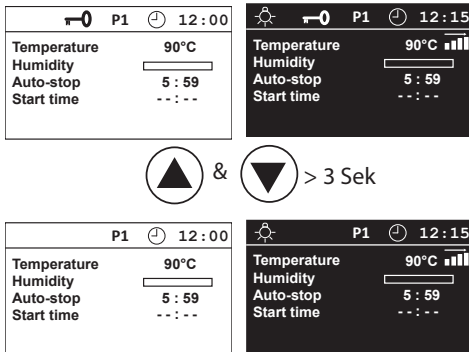

Activate / deactivate the Safety (only with existing safety system)

If Safety is not activated, neither the one-time preselection time, nor the daily preselection time functions (displayed, but not adjustable).

The control can be switched off via ON / OFF switch.

Activate



Deactivate



Activate / deactivate the Life - Guard

Life - Guard is a settable relatively short time, e.g. 20 minutes, after which the sauna unit is switched off, except for the cabin lighting. After this time has expired the unit can be switched on again by pushing the **MODE**-button for the set time.

Activate

P1 12:00	
Temperature	90°C
Humidity	<input type="text"/>
Auto-stop	5 : 59
Start time	-- : --
Life - Guard	

MODE & 

12:15	
Time of day	
12 : 15	

 / 

12:15	
Life - Guard	<input type="checkbox"/>

MODE

12:15	
Life - Guard	<input type="checkbox"/> 

 / 

12:15	
Life - Guard	<input checked="" type="checkbox"/> 

MODE > 3 Sek

P1 12:00	
Temperature	90°C
Humidity	<input type="text"/>
Auto-stop	5 : 59
Start time	-- : --
Life - Guard	20 min

Life Guard activated

Deactivate

P1 12:00	
Temperature	90°C
Humidity	<input type="text"/>
Auto-stop	5 : 59
Start time	-- : --
Life - Guard	20 min

MODE & 

12:15	
Time of day	
12 : 15	

 / 

12:15	
Life - Guard	<input checked="" type="checkbox"/>

MODE

12:15	
Life - Guard	<input checked="" type="checkbox"/> 

 / 

12:15	
Life - Guard	<input type="checkbox"/> 

MODE > 3 Sek

P1 12:00	
Temperature	90°C
Humidity	<input type="text"/>
Auto-stop	5 : 59
Start time	-- : --
Life - Guard	

Life Guard deactivated

Life-Guard

Here you can set a short period of time after which the sauna will be automatically switched off (interrupted) and may be immediately restarted for the same period of time by pressing the **MODE** button.

For example, set up 15 minutes.

If you do not press the button again after 15 minutes, the sauna heater will switch off. After completed confirmation, it will run again for 15 minutes, etc.

The setting of the „Life-Guard“ time may be made only in stand-by mode. The „Life-Guard“ function must be activated in the basic set-up menu and shown on the display.

In stand-by

P1 12:00	
Temperature	90°C
Humidity	<input type="text"/>
Auto-stop	5:59
Start time	--:--
Life - Guard	20 min

MODE

P1 12:00	
Temperature	90°C
Humidity	<input type="text"/>
Auto-stop	5:59
Start time	--:--
Life - Guard	15 min

15 sec /  > 3 sec

P1 12:00	
Temperature	90°C
Humidity	<input type="text"/>
Auto-stop	5:59
Start time	--:--
Life - Guard	15 min

P1 12:00	
Temperature	90°C
Humidity	<input type="text"/>
Auto-stop	5:59
Start time	--:--
Life - Guard	15 min

P1 12:00	
Temperature	90°C 
Humidity	<input type="text"/>
Auto-stop	5:59
Start time	--:--
Life - Guard	15 min



P1 12:00	
Temperature	90°C
Humidity	<input type="text"/>
Auto-stop	5:59
Start time	--:--
Life - Guard	20 min

MODE

P1 12:00	
Temperature	90°C
Humidity	<input type="text"/>
Auto-stop	5:59
Start time	--:--
Life - Guard	20 min



P1 12:00	
Temperature	90°C
Humidity	<input type="text"/>
Auto-stop	5:59
Start time	--:--
Life - Guard	15 min

MODE

Switching on the sauna unit with Life - Guard

P1 ⏸ 12:00	
Temperature	90°C
Humidity	<input type="text"/>
Auto-stop	5:59
Start time	--:--
Life - Guard	20 min

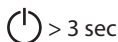

P1 ⏸ 12:00	
Temperature	90°C
Humidity	<input type="text"/>
Auto-stop	5:59
Start-time	--:--
Life - Guard	20 min

The sauna heater will now heat normal, without „Life - Guard“-time. To activate the function „Life - Guard“.

MODE

P1 ⏸ 12:00	
Temperature	90°C
Humidity	<input type="text"/>
Auto-stop	5:59
Start-time	--:--
Life - Guard	20 min

After the „Life - Guard“ - time has expired, the sauna heater is switched off and the entire display blinks.

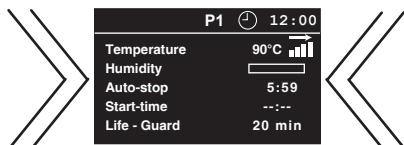

Restart

MODE

P1 ⏸ 12:00	
Temperature	90°C
Humidity	<input type="text"/>
Auto-stop	5:59
Start-time	--:--
Life - Guard	20 min

or switch off the system



P1 ⏸ 12:00	
Temperature	90°C
Humidity	<input type="text"/>
Auto-stop	5:59
Start time	--:--
Life - Guard	20 min

Note:

In the Life-Guard mode, no changes can be made to the temperature or humidity if the device is operational (active heating).



Holiday home mode

The holiday home mode allows the control system to be blocked, so that only the most essential functions are visible and can be set. The menu language must be selected every time before usage.

The holiday home mode is activated and deactivated by keeping the keys + pressed whilst activating the system via the Switch-Off.

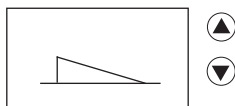

This setting is saved permanently. When the holiday home mode is active, a house symbol is permanently visible in the display.

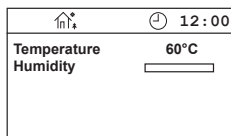

The control system functions as follows in the holiday home mode:

- The language is queried every time the control system is activated or when the system returns from the energy saving mode (confirm with „Mode“)
- The pre-select time, life-guard, auto-stop and child lock are not available
- The configuration menu with time, language and other functions is not available
- Only the temperature and humidity can be set, and the light activated

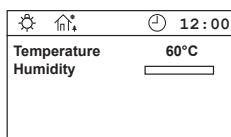

Holiday park mode

Symbol flashes

In the holiday park mode, all functions are deactivated apart from Sauna and Light (On/Off).

None of the settings, such as language, temperature, humidity, auto-stop, are available.

All values must be set before the holiday park mode is activated.

The holiday park mode is activated and deactivated by keeping the keys + Mode pressed whilst activating the system via the Switch-Off.

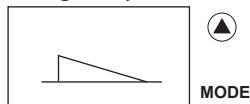

This setting is saved permanently. The house symbol in the display flashes when the holiday park mode is active.

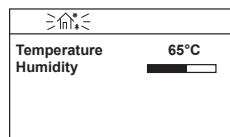

The control system functions as follows in the holiday park mode:

- The pre-select time, life-guard, auto-stop, child lock and holiday home mode are not available
- The configuration menu with time, language and other functions is not available
- The temperature and humidity cannot be set
- The sauna can only be set On/Off, and the light activated
- Light follow-up time: 10 Min.

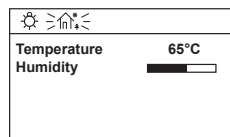

Heating time limitation

The maximal heating time may be set with a jumper on the display printed circuit board to 6 or 12 hours or to unlimited operation time. The jumper is located at the top edge of the board as shown below. To set the jumper you will need to use tweezers or fine pliers. Alternatively you may also take the board out of the housing by removing four mounting screws.

Notice for sauna: Heating time above 6 h is only permitted for certain commercial sauna cabins and may be restricted by the local legal regulations.

By unlimited heating time the control unit will not stop unless switched off manually.

Once the maximal heating time has been set the user will be able to select the heating time up to the defined limitation.



Such work may be carried out exclusively by an expert. Prior to any kind of work disconnect the control unit from the power supply on all phases. (Switch off main switch, or trip the ground circuit breaker). **Risk of electric shock!**

Loosen the four screws on the opened unit that hold the circuit board.

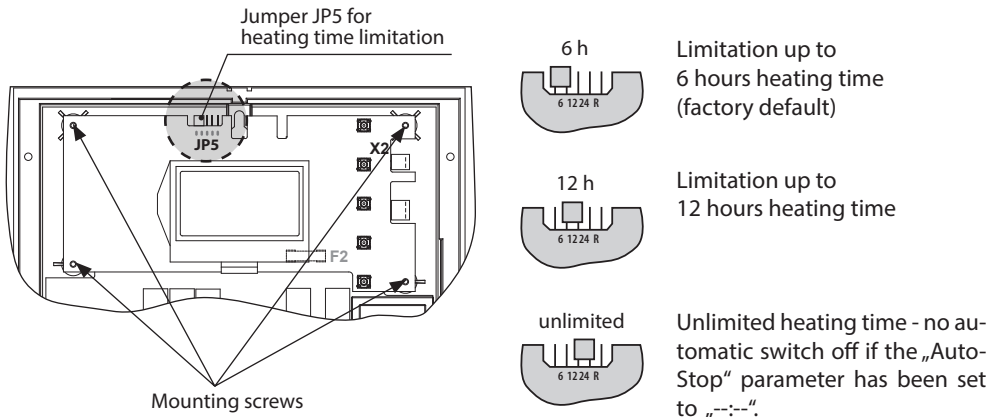

Attention!

Make sure to disconnect the control from power before changing the heating power limitation. Setting the heating time limitation without disconnecting the power may damage the electronic.

Device fuses

The control unit is fitted with two protective fuses which are mounted on the main relay board of the unit. These fuses protect the electronics on the board and the light outputs.

Notice: fuses do not mean absolute protection, in an unlikely case of a power surge or a short circuit with particularly fast voltage increase the electronic components may be still be affected.

Unit fuses

F1 = F 2A H 250V Fuse electronics primary, light (and fan if available)

F2 = T 315 mA L 250V Fuse of the electronics secondary

 Only allow a specialist to carry out this work. Before working on the open control unit, disconnect all poles from the mains. (Switch off the master switch, or trigger the FI switch). **Risk of an electrical shock!**

Loosen the four screws on the opened unit that hold the circuit board.

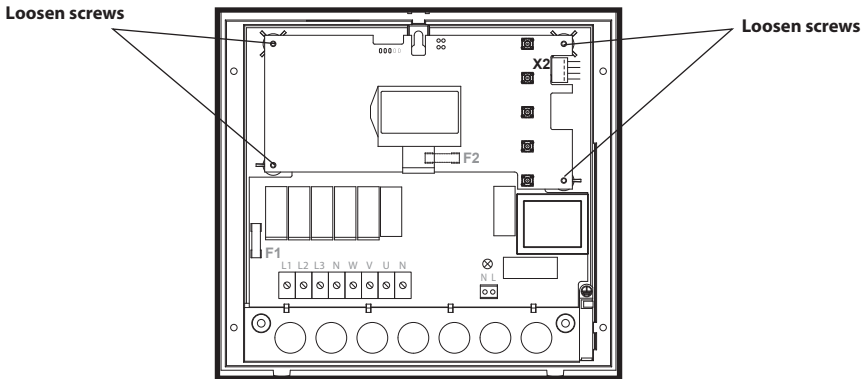

Display PCB

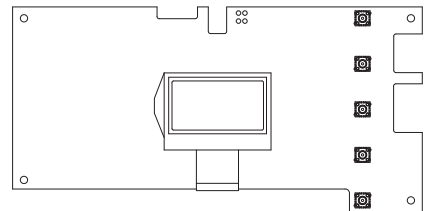

Relais PCB*

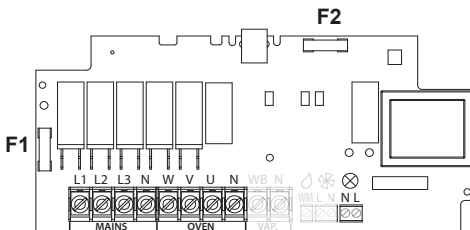





*) specific layout of the board and its components may vary slightly from model to model.

Error messages

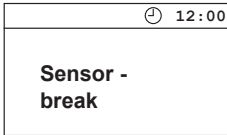
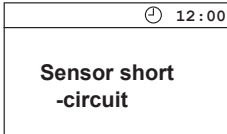
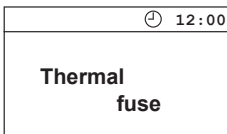
The control unit continuously monitors the sensor for short circuits and interruptions. At the same time, the system checks to ensure that there is enough water in the vaporizer tank.

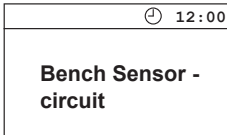
The error messages appear as follows:

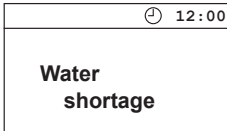
Display	Cause	Remedy
 <p>12:00 Sensor - break</p>	<p>= interrupted room sensor circuit The temperature sensor (KTY) is faulty, or the line to the temperature sensor is interrupted.</p>	<p>Arrange for a specialist to check the lines and KTY. KTY at 20°C approx. 1.9 kΩ replace if necessary.</p>
 <p>12:00 Sensor short -circuit</p>	<p>= short-circuit in the room sensor circuit temperature sensor (KTY) is faulty, or the line to the temperature sensor has a short circuit.</p>	<p>Arrange for a specialist to check the lines and KTY.</p>
 <p>12:00 Thermal fuse</p>	<p>= interrupted limiter circuit The temperature fuse (139°C) has triggered or the line to the temperature fuse is interrupted.</p>	<p>Arrange for a specialist to check the lines and temperature fuse.</p>
 <p>12:00 Bench Sensor - break</p>	<p>= interrupted bench sensor</p>	<p>Arrange for a specialist to check the lines and KTY. KTY at 20°C approx. 1.9 kΩ replace if necessary.</p>
 <p>12:00 Bench Sensor - circuit</p>	<p>= short circuit bench sensor</p>	<p>Arrange for a specialist to check the lines and KTY. KTY at 20°C approx. 1.9 kΩ replace if necessary.</p>
 <p>12:00 humidity sensor- circuit</p>	<p>= short circuit in the humidity sensor circuit</p>	<p>Arrange for a specialist to check the lines and sensors.</p>
 <p>12:00 Water shortage</p>	<p>= lack of water There is no more water in the vaporizer tank</p>	<p>Refill water.</p>

If no water is refilled, the system will completely switch off after 2 minutes. To restart the system, it first needs to be switched off via the  button, the vaporizer tank needs to be filled and then the system should be started as usual.

 **Caution, there are hot parts in the tank. Large quantities of steam may be created when filling the tank with cold water. Risk of scalding!**

The device „Switch-off“ switch

The control unit is equipped with a “Switch-off” rocker switch.

You will find this switch on the top side of the housing by Econ series control units.

This switch allows to switch the control unit to the standby mode (notice the heating will not start), to switch the control unit completely off (disconnect from power) or to switch the control unit off but to leave the light switched on.

Notice: if you leave the Econ control units switched off for more than 24 h the time setting will be lost. Other settings will be saved. You will have to repeat setup and re-confirm the settings.

Switch-off rocker

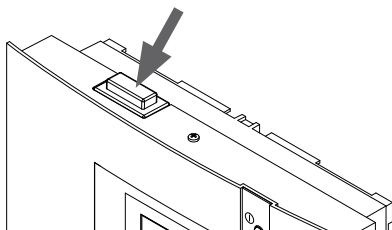

Note!

When switching the switch-off rocker from Pos. I to Pos. II, you will be at the intermediate position 0 for approx. 1s.



Attention! Parts of the printed circuit board will still remain energized in the switched off condition! Risk of electric shock!

Switch setting 0

Press the switch on the lower side of the rocker to the first latch (**switch setting 0**). The switch will be in the middle position. The unit is now completely switched off (disconnected).

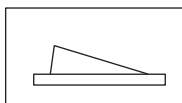

Device switched on.
(default Position I)

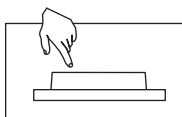

Device switched off
(completely);
Position 0.

Switch setting II

To turn the light on in the cabin while the unit is still disconnected (for maintenance and cleaning) push the left side of the rocker to the second latch (**switch setting II**).

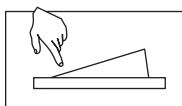

Light enabled;
Device switched off.
Position II.

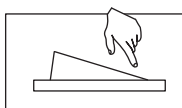

Switch setting I

To make the unit ready for operation, switch back to the initial position (**switch setting I**). The unit will return to stand-by mode.



Device switched on.
Position I.

Reset control to factory settings:

Restart control via the switch-off rocker and keep the buttons **MODE**, ,  pressed. After the appearance of the picture, press the keys **MODE**,  for > 3 sec.



Recycling

Devices or lighting elements that will not be used any longer have to be handed in at a recycling station according to regulation 2012/19/EU. Do not dispose it with the normal household waste.



Service Address:

EOS Saunatechnik GmbH
Schneiderstriesch 1

35759 Driedorf, Germany

Tel: +49 (0)2775 82-514

Fax: +49 (0)2775 82-431

servicecenter@eos-sauna.de

www.eos-sauna.de

Please retain this address together with the installation guide for further references.

To help us answer your questions quickly and competently please provide the information printed on the type shield including the model, item no. and serial no., in all inquiries.

Equipment commissioning date:

Stamp and signature of the authorized electrician:

General Terms and Conditions of Service

I. Scope

Unless otherwise agreed in writing in a specific case, these terms and conditions of service shall apply to service operations, including examining and repairing complaints. All our existing or future legal relationships shall be governed solely by the following terms and conditions of service. Our recognition of any conflicting terms and conditions of the Ordering Party shall be conditional upon our having given our express written consent to their applicability. We hereby expressly object to any terms and conditions of the Ordering Party contained in its General Terms and Conditions of Business or order confirmation. If order confirmations or deliveries are accepted without reservation, this shall not be deemed to constitute recognition of such terms and conditions. Any ancillary agreements or amendments must be confirmed in writing.

II. Costs

The Ordering Party shall bear the following costs in connection with the service operation:

- De-installation/installation and electrical works (connection / disconnection).
- Transportation, postage and packaging.
- Function testing and troubleshooting including inspection and repair costs.

There shall be no third-party billing.

III. Obligations / Ordering Party's cooperation

The Ordering Party shall provide free-of-charge assistance to the manufacturer in carrying out the service operation.

In the case of a warranty claim the manufacturer shall provide the required replacement parts to the Ordering Party free of charge.

IV. Service visit by the manufacturer

In the event that it is essential that a manufacturer employ carry out the service operation on site, this must be agreed in advance. Where the main reason for the service call is not the fault of the manufacturer, any costs incurred shall be recharged to the Ordering Party after the service visit and shall be paid as per agreed payment terms.

V. Liability

The manufacturer shall assume liability in accordance with the currently applicable statutory regulations. The packaging for all of our products is designed for the shipping of individually packed goods (pallet). We expressly

point out that our packaging is not suitable for individual shipments via parcel post. The manufacturer shall accept no liability for damage incurred as a result of improper packaging in an individual shipment.

VI. Manufacturer's Guarantee

The manufacturer's guarantee shall apply only in the event that installation, operation and maintenance have been carried out in accordance with the manufacturer's specifications contained in the installation instructions and instructions for use.

- The guarantee period shall commence from the date on which proof of purchase is provided and shall be limited, in principle, to 24 months.
- Guarantee services shall be performed only if the original proof of purchase relating to the equipment can be presented.
- Any and all guarantee claims shall become void if modifications are made to the equipment without the manufacturer's express consent.
- Any guarantee claim shall likewise become void in the case of defects that arise due to repairs or interventions made by unauthorized persons or due to improper use.
- In the case of guarantee claims, the serial and article numbers must be indicated together with the product name and a meaningful description of the fault.
- This guarantee shall cover defective equipment parts, with the exception of usual wear parts. Wear parts are, among others, lamps, glass parts, heating elements and sauna stones.
- Only original replacement parts may be used within the warranty.
- Service visits by outside companies shall require a written order to be issued by our service department.
- The equipment in question shall be sent to our service department by the Ordering Party and at its expense.
- Electrical installation and connection works in the event of service or replacement shall be carried out at the Customer's expense and shall not be borne by the manufacturer.

Complaints in respect of our products shall be reported to the responsible authorized dealer and shall be exclusively handled via the latter.

The manufacturers General Terms and Conditions of Business, which can be found at www.eos-sauna.com/agb, shall apply in addition to the foregoing terms and conditions of service.

As of 08/2018